



Teca

Model Reg. n. TO 2011/29 • Design Reg. n. TO 2009/31

La Teca si presenta sobria ed elegante, volutamente minimalista ed essenziale.

La particolare esposizione in orizzontale delle bottiglie diventa parte della scenografia.

È un oggetto dal design inconfondibile destinato a rendere unico ogni ambiente in cui è inserito.

Teca has a clean and elegant style, deliberately minimalistic and essential.

The horizontal bottle arrangement blends in with the scene.

It is an item with unmistakable design that will make any setting unique.

Teca est sobre et élégante, intentionnellement minimaliste et essentielle. L'exposition horizontale particulière des bouteilles devient partie intégrante de la scénographie.

C'est un objet avec un design indubitablement destiné à rendre unique chaque environnement dans lequel il est inséré.



OPTIONAL TECA *14

Le vetrine *14 della serie Teca vengono fornite senza allestimenti. È possibile personalizzare l'allestimento interno scegliendo uno o più optional tra quelli di seguito elencati.

The units *14 of the Teca series are supplied without internal fittings. You can customize the interior by choosing one or more of the following options.

Les modules *14 de la serie Teca sont fournis sans accessoires. Vous pouvez personnaliser l'intérieur en choisissant une ou plusieurs options parmi celles indiquées ci-dessous.

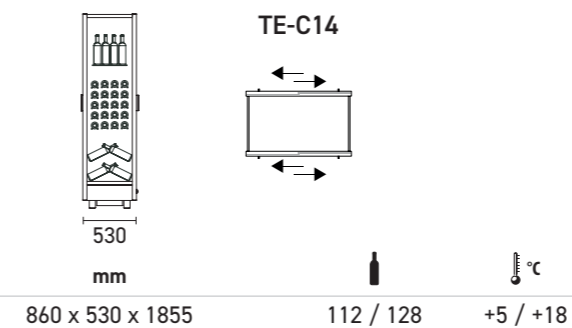
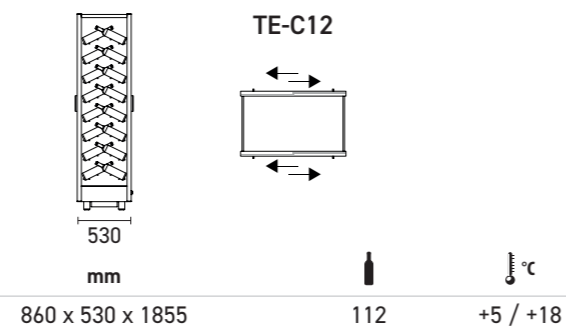
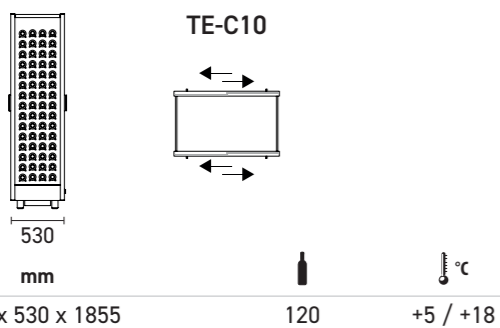
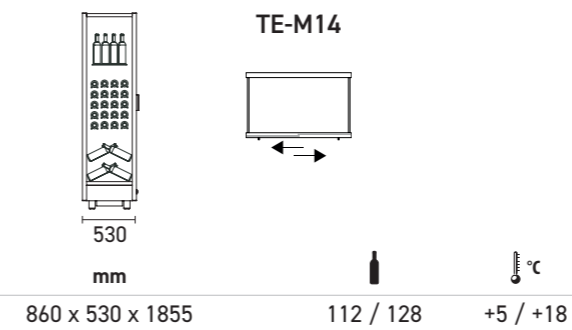
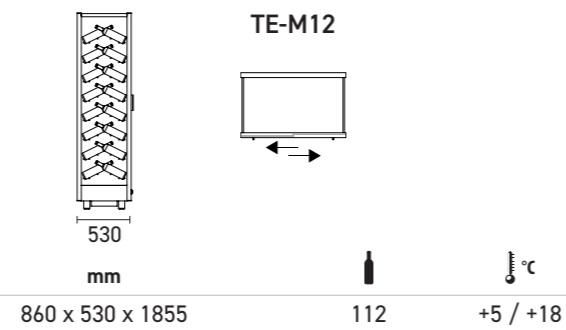
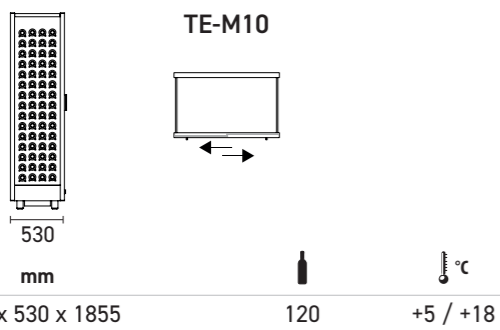
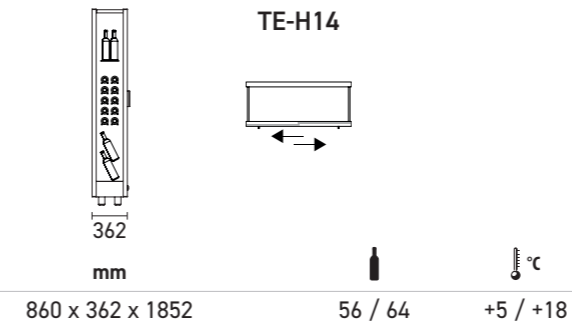
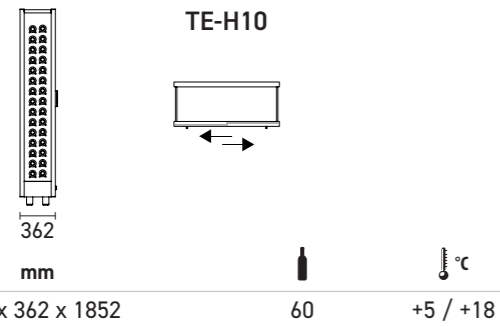

TE-M / TE-C



OPT-14T-BF

Bottiglie frontali · Front neck bottles · Bouteilles à col avant

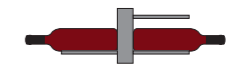

OPT-14-BO

Bottiglie orizzontali · Horizontal bottles · Bouteilles horizontales



OPT-14T-BI

Bottiglie inclinate · Reclined bottles · Bouteilles inclinées



OPT-14T-PR

Piano regolabile · Adjustable shelf · Etagère réglable

TE-H



OPT-14H-BO

Bottiglie orizzontali · Horizontal bottles · Bouteilles horizontales



OPT-14TH-BI

Bottiglie inclinate · Reclined bottles · Bouteilles inclinées



OPT-14TH-PR

Piano regolabile · Adjustable shelf · Etagère réglable

COLORS (Pag. 110)



Si inserisce con semplicità in qualsiasi tipo di ambiente e risulta esteticamente apprezzabile anche in contrasto ad oggetti vintage.
Modello rappresentato TE-H10 con cornice lineare in colore nero.

It suits with ease any type of environment and its looks complement well even vintage furniture.
Pictured here is TE-H10 with linear frame in black finish.

Elle s'intègre simplement dans tout type d'environnement et résulte esthétiquement valable même si mélangé aux objets vintage.
Modèle représenté TE-H10 avec cadre linéaire noir.



Teca

La finitura della cornice in foglia argento conferisce alla Teca un'eleganza senza tempo. Massima personalizzazione dell'allestimento interno in tutti i modelli della serie 14.

The silver leaf frame finish gives Teca a timeless elegance. High customizability of internal fittings for all 14 series models.

La finition du cadre avec feuille d'argent donne à Teca une élégance intemporelle. Totale possibilité de personnalisation de l'aménagement intérieur dans tous les modèles 14.

La Teca ha una struttura in alluminio rivestita da una cornice in legno realizzabile con finiture e colori diversi. Questa scelta costruttiva permette di sostituire con semplicità sia le parti in vetro che la cornice in legno.

La Teca è disponibile nella versione a profondità ridotta (H) con condensatore statico installato nella parte posteriore e nella versione standard (M / C) dove è installato l'innovativo sistema di refrigerazione centrale basato sul posizionamento della serpentina di raffreddamento al centro della vetrina. Questo sistema consente la costruzione della vetrina centrale (C) con porte scorrevoli su entrambi i lati.

Teca features a wooden-clad aluminum structure that comes in different colors and finishes. This design choice allows for easy replacement both of glass parts and the wood frame.

Teca is available with reduced depth (H) with static condenser installed in the back, and standard depth (M / C) equipped with the innovative central refrigeration system with the cooling coil in the middle of the cabinet. This system makes it possible to have a central (C) system with sliding doors on both sides.

La Teca a une structure en aluminium recouvert d'un cadre en bois qui peut être réalisé avec différentes finitions et couleurs. Ce choix constructif permet de remplacer facilement soit les parties en verre soit le cadre en bois.

La Teca est disponible en version à profondeur réduite (H) avec condenseur statique installé à l'arrière et dans la version standard (M / C) où le système de réfrigération central innovant est conçu par le positionnement du serpentin de refroidissement au milieu de l'armoire. Ce système permet la construction de la vitrine centrale (C) avec des portes coulissantes sur des deux côtés.

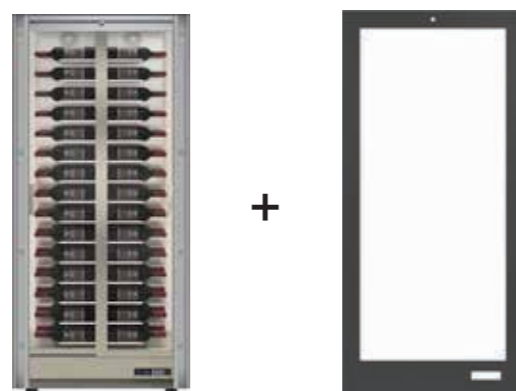

La Teca è composta da due elementi distinti che sono codificati e quotati separatamente:

- Vetrina con struttura in alluminio
- Cornice di finitura in legno/MDF

La cornice frontale viene applicata con bottoni a pressione pertanto la sostituzione è semplice ed immediata.

Teca is made of two separate elements and references:

- Unit with aluminium structure
- MDF/wood decorative frame.

The frame is mounted with a snap-on button system and therefore easy to replace.

Teca est composé de deux éléments distincts qui ont des codes séparés:

- Vitrine avec structure en aluminium
- Cadre de finition en bois / MDF

Le cadre/s de finition sont appliqué parmi des boutons pression donc le remplacement est simple et immédiat.

I modelli TE-H10 e TE-H14 devono essere fissati alla parete utilizzando le staffe in dotazione.

The TE-H10, TE-H14 models must be fixed to the wall with the provided brackets.

Les modèles TE-H10, TE-H14 sont à fixer contre le mur avec les supports fournis.

OPTIONAL (Pag. 102)

Di serie su tutti i modelli

Standard on all models

Standard sur tous les modèles



OPT-RGB



OPT-CBD



OPT-ABK

Optional disponibili su tutti i modelli

Options available on all models

Disponible en option sur tous les modèles

CARATTERISTICHE TECNICHE

Specifications • Caracteristiques techniques

Struttura in alluminio	Aluminium structure	Structure en aluminium
Cornice in MDF	MDF frame	Cadre en MDF
Porte scorrevoli, fianchi e top con vetrocamera - protezione UV	Sliding doors, sides and top in double glass - anti-UV protection	Portes coulissantes, les côtés et le dessus en double vitre - protection anti UV
Serratura con chiave	Lock with key	Serrure à clé
Interni in alluminio	Aluminium interior	Intérieur en aluminium
Illuminazione a LED bianco caldo (3000 K - 30 led/mt - 1,12 W / mt - 130 lumen / mt)	Cold white daylight LED (3000 K - 30 led/mt - 1,12 W / mt - 130 lumen / mt)	LED blanc day-light chaud (3000 K - 30 led/mt - 1,12 W / mt - 130 lumen / mt)
Refrigerazione statica e ventilata	Static and ventilated refrigeration	Réfrigération statique et ventilé
Termoregolatore digitale	Digital temperature controller	Thermorégulateur digital
Sbrinamento automatico ed evaporazione automatica della condensa	Automatic defrosting and automatic evaporation system	Dégivrage et évaporation de la condensation automatiques
Sistema antivibrazione	Anti-vibration system	Système anti-vibration
Filtro a carboni attivi ricaricabile	Rechargeable active carbon filter	Filtre à charbon actif rechargeable
Compressore ad inverter	Inverter compressor	Compresseur onduleur

LATO POSTERIORE

Back side • Face arrière

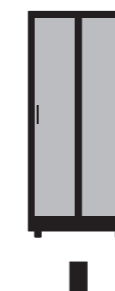

Lato posteriore chiuso
Closed back
Arrière fermé



Porte su ambo i lati
Doors on both sides
Portes des deux côtés

CONFIGURATORE ONLINE







Online builder • Outil de configuration en ligne



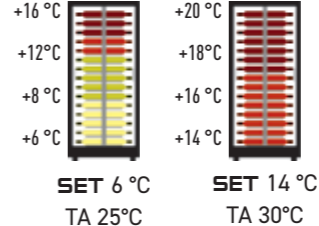
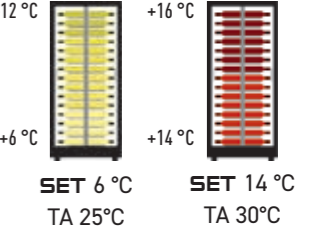

Nell'area "Configuratori" del sito www.exposrl.com è disponibile uno strumento di visualizzazione che permette di vedere la Teca Vino da ogni prospettiva e scegliere tipologia e colore della Cornice.

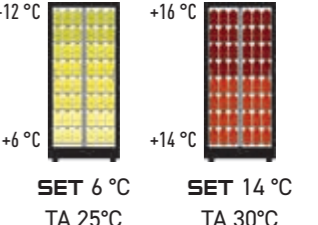
The "Configurator" section of the website www.exposrl.com features a viewing tool that lets you see the Teca Vino from every perspective and choose the type and finish among the available frames.

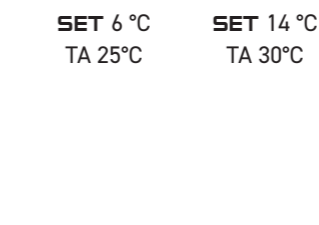
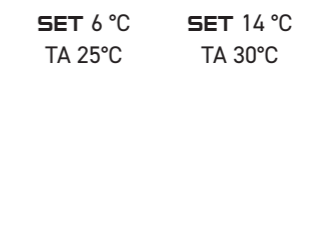
Dans la section "Configurateur" du site www.exposrl.com, vous disposez d'un outil de visualisation qui vous permet de voir Teca Vino à partir de toutes les perspectives et de choisir le type et la couleur des différents cadres disponibles.

CODE	mm LxPxH		N. 0,75 LT	LT	Energy	Pmax W I max A	V	HFC	LIGHT	dB	Kg	m³	OFF	ON
	mm LxPxH													
	860 x 362 x 1852		60		G	150 W 1,2 A		R 600 a			97			
	1000 x 800 x 2060		H 370 Ø 93	293	N	289	230 50-60Hz		●●●	37	105	1,7		
	860 x 530 x 1855		120		F	424 W -		R 600 a			107			
	1000 x 800 x 2060		H 370 Ø 90	540	N	468	230 50-60Hz		●●●	39	132	1,7		
	860 x 530 x 1855		120		G	424 W -		R 600 a			120			
	1000 x 800 x 2060		H 370 Ø 90	570	N	514	230 50-60Hz		●●●	39	145	1,7		
	860 x 530 x 1855		112		G	424 W -		R 600 a			107			
	1000 x 800 x 2060		H 400 Ø 120	540	N	468	230 50-60Hz		●●●	39	132	1,7		
	860 x 530 x 1855		112		F	424 W -		R 600 a			120			
	1000 x 800 x 2060		H 400 Ø 120	570	N	514	230 50-60Hz		●●●	39	145	1,7		

Teca

CODE	mm LxPxH	mm LxPxH	N. 0,75 LT	H Ø	Energy	Pmax W I max A	KWh annum	⚡ V	HFC	LIGHT	dB	Kg	m³	OFF	ON
	860 x 362 x 1852	OPT14	293	G	150 W 1,2 A	230 50-60Hz	R 600 a	97	37	1,7	105	103	1,7	SET 6 °C TA 25°C	SET 14 °C TA 30°C
	1000 x 800 x 2060														
	860 x 530 x 1855	OPT14	540	F	424 W -	230 50-60Hz	R 600 a	103	39	1,7	128	103	1,7	SET 6 °C TA 25°C	SET 14 °C TA 30°C
	1000 x 800 x 2060														
	860 x 530 x 1855	OPT14	570	G	424 W -	230 50-60Hz	R 600 a	116	39	1,7	141	116	1,7	SET 6 °C TA 25°C	SET 14 °C TA 30°C
	1000 x 800 x 2060														

C. Cornice esclusa - Frame not included - Cadre non inclus

S. Senza allestimento interno - Without inside fittings - Sans aménagement intérieur

OPT14 - Pag. 103 

CORNICI TECA

CODE	€			Dune			mm LxPxH	Kg	Kg	m³
	MO1	RAL9010	RAL9005	VO1	VO2	DO1				
T1-H*	●	●	●	●	●	●	-	-	-	-
T1-M*	●	●	●	●	●	●	-	-	-	-
T1-C*	●	●	●	●	●	●	-	-	-	-

* I colori RAL vengono realizzati su supporto di MDF in finitura opaca 20 gloss (finitura lucida 100 gloss su richiesta).

* RAL colours are made on MDF 20-gloss matte finish (100-gloss finish available on request)

* Les couleurs RAL sont réalisés sur support en MDF en finition matte 20 Gloss (ou bien sur demande brillante 100 Gloss).

Di serie - Standard



Filtro a carboni attivi

Filtro a carboni attivi ricaricabile. È possibile estrarre il filtro dalla vetrina e sostituire i carboni in pochi minuti. Permette un naturale ricircolo di aria nelle vetrine vino.

Activated carbon filter

Rechargeable activated carbon filter. It is possible to remove the filter from the cabinet and replace the coals in few minutes. It allows a natural circulation of air in the wine showcase.

Filtre à charbon actif

Filtre à charbon actif rechargeable. Il est possible d'enlever le filtre de la vitrine et de remplacer les charbons en quelques minutes. Il permet une circulation naturelle de l'air dans les vitrines à vins.

Termoregolatore digitale

L'utilizzatore ha la possibilità di impostare la vetrina con o senza ventilazione interna e di conseguenza ottenere, all'interno dello stesso vano, una temperatura uniforme o differenziata per tutte le tipologie di vino.

Digital temperature controller

The user can switch internal ventilation on or off to have – inside the same compartment – either the same compartment – either an even or differentiated temperature for all types of wine.

Thermorégulateur numérique

L'utilisateur peut régler la vitrine avec ou sans ventilation interne et donc obtenir – dans le même compartiment – une température uniforme ou différenciée pour tous types de vin.

Optional

Controller RGB

Installazione impianto led RGB (30 led/m - 7,2 Wm - 550 lumen/m - 12 V) in sostituzione dei led bianchi standard. Telecomando per gestione colori, programmazione effetti ed intensità luminosa. Il colore bianco dei led RGB è bianco freddo (6.000-6.500 K).

RGB controller

Replaces standard white LEDs with RGB LEDs. Various colours, lighting effects and dimming can be selected with the included remote control. RGB's white hue is very cool (6000-6500°K). We suggest not using the RGB LEDs for cold dish and cured meats/cheese units.

Regulateur RGB

Installation système led RGB (30 led/m - 7,2 Wm - 550 lumen/m - 12 V) à la place des LEDs blancs standard. Télécommande pour la gestion des couleurs, effets de programmation et intensité lumineuse. La couleur blanche de la led RGB est un blanc froid (6.000-6.500 K).

OPT-RGB

Controller bianco dinamico

Installazione impianto led BIANCO DINAMICO (140 led/m - 19,2 Wm - 2.000 lumen/m - 24 V) in sostituzione dei led bianchi standard. Telecomando per gestione colore bianco (variabile da bianco caldo 2700 K a bianco freddo 6000 K). Controllo intensità luminosa.

Dinamic white controller

Installation of DYNAMIC WHITE (140 led/m - 19,2 Wm - 2.000 lumen/m - 24 V) setup in place of standard white LEDs. Remote control for white setting (ranging from warm white 2700 K to cold white 6000 K). Dimmer.

Regulateur blanc dynamique

Installation système LED BLANC DYNAMIQUE (140 led/m - 19,2 Wm - 2.000 lumen/m - 24 V) à la place des LEDs blancs standard. Télécommande pour la régulation du blanc (variable de blanc chaud 2700 K à blanc froid 6000 K). Contrôle intensité éclairage.

OPT-CBD

All black

Verniciatura a polveri epossidiche colore nero opaco di tutte le parti metalliche interne (montanti, pannelli interni, accessori, piano) ed esterne (profili porte, telai, maniglie, carter). A seconda dei modelli, alcuni particolari tipo viti o reggimensole vengono mantenuti in finitura inox.

All black

Black matte epoxy powder coating of all internal (beams, internal panels, accessories, shelf) and external (door profiles, frame, handles, flank) metal parts. Depending on model, some details i.e. screw caps or shelf supports remain in stainless steel finish.

All black

Peinture en poudre époxy de couleur noir mat de toutes les parties métalliques internes (montants, panneaux internes, accessoires, dessus) et externes (profils de portes, cadres, poignées, carters). Selon les modèles, certains détails comme des vis ou les supports d'étagère sont conservés dans une finition en acier inoxydable.

OPT-ABK

Porte colore nero

Verniciatura a polveri epossidiche colore Nero della parte esterna. MOD (profili porte, telaio di battuta delle porte, maniglie) TECA (profili porte maniglie).

Door frame in black color

Black epoxy powder painting of the external part. MOD (door profile, frame, handles) TECA (door profile, handle).

Portes en couleur noir

Laquage de l'extérieur avec vernis à poudre époxy noire. MOD (profilés de porte, châssis de porte, poignées) TECA (profilés, portes et poignées).

OPT-PCN

OPTIONAL TECA - MOD *14/24

Le vetrine *14/24 della serie Teca e Mod vengono fornite senza allestimenti. È possibile personalizzare l'allestimento interno scegliendo uno o più optional tra quelli di seguito elencati.

The units *14/24 of the Teca and Mod series are supplied without internal fittings. You can customize the interior by choosing one or more of the following options.

Les modules *14/24 de la serie Teca et Mod sont fournis sans accessoires. Vous pouvez personnaliser l'intérieur en choisissant une ou plusieurs options parmi celles indiquées ci-dessous.

Optional Teca - Mod M / C - 14 / 24



OPT-14T-BF
OPT-14MP-BF

Bottiglie frontali
Piano in plexiglas con staffette di fissaggio. Il sistema è regolabile in altezza con passo di 5 cm in funzione delle bottiglie inserite. Ogni piano può contenere 4 bottiglie.

Front neck bottles

Perspex shelf with mounting brackets. The system is adjustable in height, shelves can be fitted every 5 cm, depending on how many and what kind of bottles you want to insert. Each shelf can hold 4 bottles.

Bouteilles à col avant

Tablette en Plexy avec supports de montage. Le système est réglable en hauteur, les étagères peuvent être installées tous les 5 cm selon le nombre et le type de bouteilles que vous souhaitez insérer. Chaque étagère peut accueillir 4 bouteilles.



OPT-14T-BF-3
OPT-14MP-BF-3

Bottiglie frontali
Piano in plexiglas con staffette di fissaggio. Il sistema è regolabile in altezza con passo di 5 cm in funzione delle bottiglie inserite. Ogni piano può contenere 3 bottiglie Magnum.

Front neck bottles

Perspex shelf with mounting brackets. The system is adjustable in height, shelves can be fitted every 5 cm, depending on how many and what kind of bottles you want to insert. Each shelf can hold 3 Magnum bottles.

Bouteilles à col avant

Tablette en Plexy avec supports de montage. Le système est réglable en hauteur, les étagères peuvent être installées tous les 5 cm selon le nombre et le type de bouteilles que vous souhaitez insérer. Chaque étagère peut accueillir 3 bouteilles Magnum.



OPT-14T-BI
OPT-14MP-BI

Bottiglie inclinate
Struttura realizzata con laterali in plexiglas e tondini in alluminio. Questa struttura può essere posizionata a diverse altezze con interasse minimo di 20 cm. Può contenere fino 7 bottiglie classiche da 0,75 l oppure 4 bottiglie Magnum.

Inclined bottles

Structure composed of Perspex sides and aluminum rods. This structure can be positioned at different heights with a minimum of 20 cm spacing. It can hold 7 standard 0.75 l bottles or 4 Magnum.

Bouteilles inclinées

Structure avec latéraux en Plexy et tiges en aluminium. Cette structure peut être positionnée à des hauteurs différentes avec un minimum de 20 cm de distance. Elle peut accueillir 7 bouteilles classiques de 0,75 l ou 4 Magnum.



OPT-14-BO

Bottiglie orizzontali
3 Kit composti da 8 tondini cadauno (totale 24 tondini). Con ogni kit è possibile esporre 3 file da 8 bottiglie (24 bottiglie totali) ed è regolabile in altezza ogni 10 cm.

Horizontal bottles

3 kits made of 8 rods each (24 rods in total). Each kit stores 3 rows of 8 bottles (24 bottles total) and can be adjusted every 10cm in height.

Bouteilles horizontales

3 Kits comprenant 8 tiges chacun (total 24 tiges). Avec chaque KIT on peut exposer 3 files de 8 bouteilles (24 bouteilles en total) et il est réglable en hauteur à chaque 10 cm.



OPT-14T-PR
OPT-14MP-PR

Piano regolabile
Piano regolabile in vetro temperato con reggi mensole. Il piano è regolabile con passo 5 cm. È molto utile per il posizionamento di bottiglie in verticale, bottiglie e decanter.

Adjustable shelf

Tempered glass adjustable shelf with supports. The shelf can be adjusted in steps of 5 cm. It is very useful for positioning vertically bottles, glasses and decanters.

Etagère réglable

Étagère réglable en verre trempé avec supports. L'étagère peut être installée chaque 5 cm. Il est très utile pour positionner verticalement les bouteilles, les verres et les carafes decanters.

Optional Teca - Mod H - 14 / 24



OPT-14TH-BI
OPT-14MPH-BI

Bottiglie inclinate
Piano in plexiglass termoformato. Questo accessorio può essere posizionato a diverse altezze e può contenere 4 bottiglie da 0,75 cl.

Tilted bottles

Thermoformed plexiglass ledge. This component can be positioned at different heights and can contain 4 0.75 l bottles.

Bouteilles inclinées

Support bouteilles en plexiglas thermoformé. Cet accessoire peut être placé à différentes hauteurs et peut contenir 4 bouteilles de 0,75 cl.



OPT-14TH-BI-3
OPT-14MPH-BI-3

Bottiglie inclinate
Piano in plexiglass termoformato. Questo accessorio può essere posizionato a diverse altezze e può contenere 3 bottiglie da 0,75 cl.

Tilted bottles

Thermoformed plexiglass ledge. This component can be positioned at different heights and can contain 3 0.75 l bottles.

Bouteilles inclinées

Support bouteilles en plexiglas thermoformé. Cet accessoire peut être placé à différentes hauteurs et peut contenir 3 bouteilles de 0,75 cl.



OPT-14H-BO

Bottiglie orizzontali
4 Kit composti da 4 tondini cadauno (totale 16 tondini). Con un kit è possibile esporre 4 file da 4 bottiglie (16 bottiglie totali) ed è regolabile in altezza ogni 10 cm.

Horizontal bottles

4 kits made of 4 rods each (16 rods in total). Each kit stores 4 rows of 4 bottles (16 bottles total) and can be adjusted every 10cm in height.

Bouteilles horizontales

4 Kits comprenant 4 tiges chacun (total 16 tiges). Avec chaque KIT on peut exposer 4 files de 4 bouteilles (16 bouteilles en total) et il est réglable en hauteur à chaque 10 cm.



OPT-14TH-PR
OPT-14MPH-PR

Piano regolabile
Piano regolabile in vetro temperato con reggi mensole. Il piano è regolabile con passo 5 cm. È molto utile per il posizionamento di bottiglie in verticale e bicchieri.

Adjustable shelf

Tempered glass adjustable shelf with supports. The shelf can be adjusted in steps of 5 cm. It is very useful for positioning vertically bottles and glasses.

Etagère réglable

Étagère réglable en verre trempé avec supports. L'étagère peut être installée chaque 5 cm. Il est très utile pour positionner verticalement les bouteilles et les verres.

IMPIANTO A REFRIGERAZIONE CENTRALE (brevettato) - condensazione ventilata

Installato su tutte le vetrine profondità (510 - 530 mm)

CENTRAL COOLING SYSTEM (patented) · Installed on all cabinets with (510 - 530 mm) depth

INSTALLATION DE RÉFRIGÉRATION CENTRALE (brevétée) - condensation ventilée · Installé dans les vitrines de profondeur (510 - 530 mm)

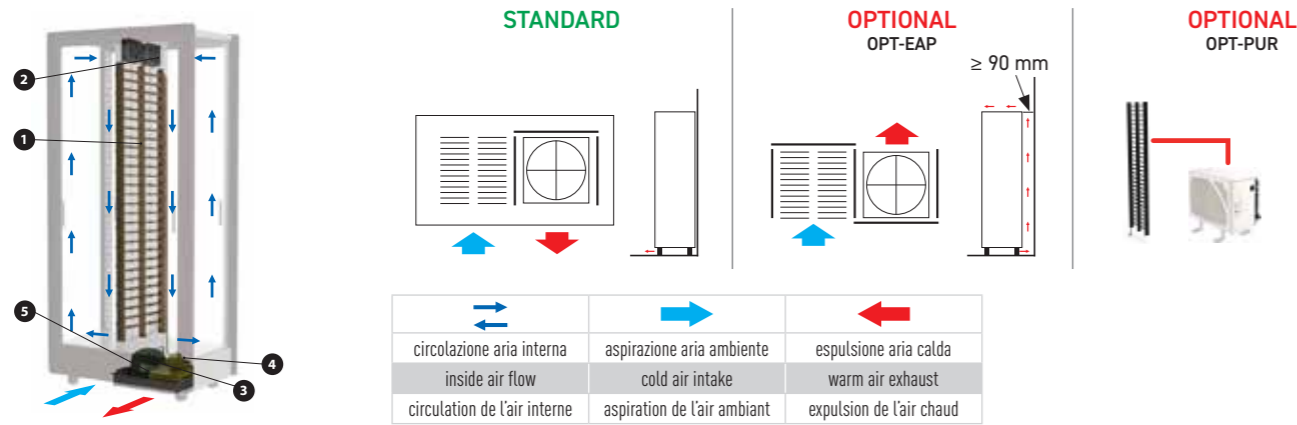

La serpentina di raffreddamento ① e le ventole di aereazione interna ② sono inserite al centro della vetrina all'interno dei pannelli di alluminio. Il compressore ③, il condensatore orizzontale con ventola a pala premente ④ e la vasca per l'evaporazione della condensa ⑤ sono inseriti in una speciale vasca ribassata. Con questa soluzione, pur installando un compressore importante (1/4 hp), l'altezza della base è limitata (150 mm) in quanto viene utilizzato lo spazio inferiore dove sono inseriti i piedi (40 mm). La circolazione dell'aria di condensazione avviene dalla parte inferiore frontale.

The cooling coil ① and the internal fans ② are installed in the middle of the cabinet inside the aluminium panels. The compressor ③, the horizontal condensing unit, the pushing fan ④ and the vat for the evaporation of the condensation water ⑤ are placed in a special lowered tank. With this solution, despite installing a high power compressor (1/4 hp), the height of the base is limited (150 mm) as it takes up the lower space where feet are located (40 mm). Condensation air circulates from the bottom front part.

Le serpentin de refroidissement ① et les ventilateurs internes ② sont insérés au milieu de la vitrine à l'intérieur des panneaux d'aluminium. Le compresseur ③, l'unité de condensation horizontale, le ventilateur avec la lame à pression ④ et le bassin de l'évaporation de l'eau de condensation ⑤ sont placés dans une cuve spéciale rébaissée. Avec cette solution, même avec un compresseur de grande puissance (1/4 HP), la hauteur de la base est limitée (150 mm), car on utilise l'espace inférieur où se trouvent les pieds (40 mm). La circulation de l'air de condensation est soufflé à travers la partie inférieure avant.

IMPIANTO A REFRIGERAZIONE POSTERIORE - CONDENSAZIONE STATICA

Installato su tutte le vetrine profondità (350 - 362 mm)

REAR COOLING SYSTEM - static condensation · Installed on all cabinets with (350 - 362 mm) depth

SYSTÈME DE RÉFRIGÉRATION ARRIÈRE - condensation statique · Installé dans toutes les vitrines en profondeur (350 - 362 mm)

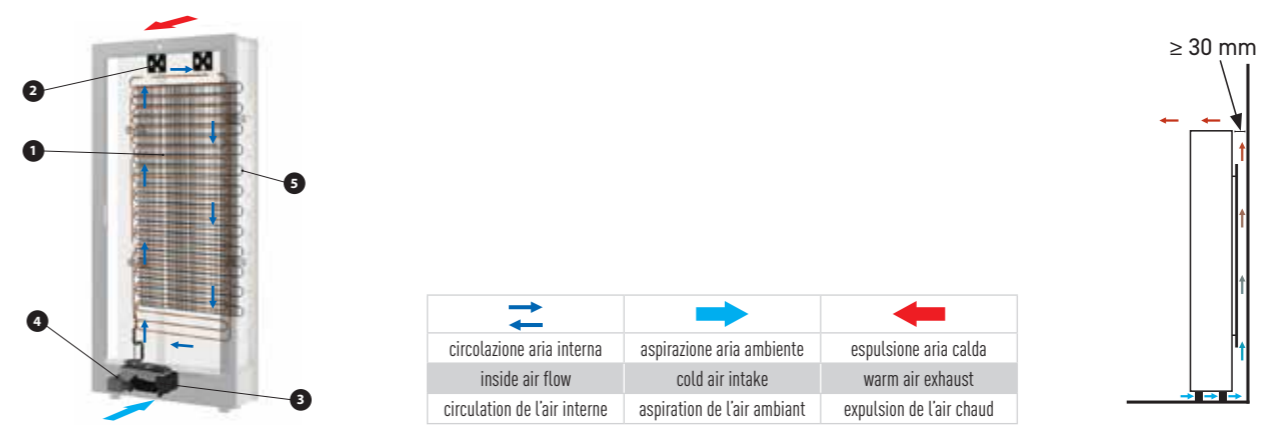

La serpentina di raffreddamento ① e le ventole di aereazione interna ② sono posizionate all'interno del vano refrigerato dietro il pannello posteriore in alluminio. Il compressore ad inverter ③ e la vasca per l'evaporazione della condensa ④ sono inseriti nella base inferiore. Il condensatore statico ⑤ è installato nel retro della vetrina. Il raffreddamento del condensatore avviene per convezione senza l'ausilio di ventole. L'aria ambiente passa sotto la base e sale nello spazio tra il retro della vetrina ed il muro, si scalda ed esce dall'alto.

The cooling coil ① and the internal aeration fans ② are placed inside the refrigerated compartment, behind the aluminum back panel. The inverter compressor ③ and the evaporation pan ④ are placed in the lower base. The static condenser ⑤ is installed in the back of the cabinet. The condenser cools down due to convection without the use of fans. Ambient air comes through under the base and rises in the gap between the back of the cabinet and the wall, gets warm and exits from the top.

Le serpentin de refroidissement ① et les ventilateurs internes ② sont positionnés à l'intérieur du compartiment réfrigéré derrière le panneau du fond en aluminium. Le compresseur onduleur inverter ③ et le réservoir d'évaporateur de condense ④ sont insérés dans la base inférieure. Le condensateur statique ⑤ est installé à l'arrière de la vitrine. Le refroidissement du condenseur se fait par convection sans l'aide de ventilateurs. L'air passe sous la base et s'élève dans l'espace entre l'arrière de la vitrine et le mur, il se réchauffe et s'échappe vers l'haut.

Espulsione aria posteriore · Air exhaust at rear · Sortie d'air arrière

CODE		
OPT-EAP	Inserimento di deflettori che convogliano l'aria calda nel lato posteriore. È necessario lasciare uno spazio di almeno 9 cm tra la vetrina ed il muro ed un'apertura nella parte superiore della vetrina che consenta l'espulsione dell'aria calda.	Insertion of deflectors which send the hot air to the back. A gap of at least 9 cm must be left between the cabinet and the rear wall and the corresponding top part must be left open to allow the expulsion of the hot air.
OPT-PUR	Le vetrine sono sprovviste di unità condensatrice. Tutte le vetrine vengono predisposte con valvola termostatica di serie. Le tubazioni per l'allacciamento alla linea frigorifera sono nella parte inferiore della vetrina. È necessario prevedere una linea di scarico per l'acqua di condensa e l'alimentazione elettrica.	The units are provided without condensing unit. They are supplied with thermostatic valve as standard. The pipes for the connection to the refrigerating line are in the lower part of the unit. It is necessary to provide a discharge pipe for the condensing water and the power supply.

Unità remota silenziata (optional)

SILENCED REMOTE UNIT (OPTION) · UNITÉ DÉPORTÉE SILENCIEUSE

Predisposizione unità remota · Setting for remote compressor · Prevision de compresseur déplacé

OPT-PUR	Le vetrine sono sprovviste di unità condensatrice. Tutte le vetrine vengono predisposte con valvola termostatica di serie. Le tubazioni per l'allacciamento alla linea frigorifera sono nella parte inferiore della vetrina. È necessario prevedere una linea di scarico per l'acqua di condensa e l'alimentazione elettrica.	The units are provided without condensing unit. They are supplied with thermostatic valve as standard. The pipes for the connection to the refrigerating line are in the lower part of the unit. It is necessary to provide a discharge pipe for the condensing water and the power supply.	Les vitrines ne sont pas équipés avec l'unité de condensation. Ils sont livrés avec vanne thermostatique en standard. Les tuyaux pour le raccordement à la ligne de production de froid sont dans la partie inférieure de la vitrine. Il est nécessaire de prévoir un tuyau d'évacuation de l'eau de condensation et l'alimentation électrique.
---------	---	---	---

CODE	N. modules	mm LxPxH		HP	HFC			* - 10 °C (TA 32)		dB 10 m - 5 m
GAS R134a										
OPT-UR01-134	1	930 x 575 x 690	Tecumseh AE 4440 Y	1/3	R134a	230 / 1 / 50	504	611	1/4 - 3/8	27 - 33
OPT-UR02-134	2	930 x 575 x 690	Tecumseh CAJ 4461 Y	1/2	R134a	230 / 1 / 50	667	882	1/4 - 1/2	28 - 34
OPT-UR03-134	3	930 x 575 x 690	Tecumseh CAJ 4511 Y	1	R134a	230 / 1 / 50	1123	1670	3/8 - 5/8	30 - 36

Le potenze sono state calcolate per una linea frigorifera non superiore a 15 metri · Compressor power is calculated considering a distance not higher than 15 meters

Puissance du compresseur est calculée en tenant compte d'une distance ne dépassant pas 15 mètres

Verniciatura a liquido • Liquid paint finish • Laquage par peinture liquide

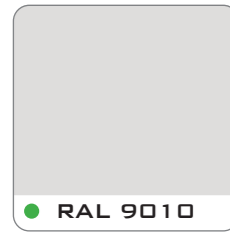

● **RAL 9010**
bianco opaco (20 gloss)
matt white (20 gloss)
blanc mat (20 gloss)

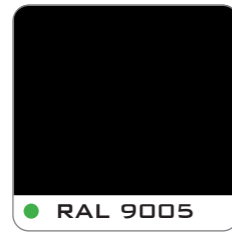

● **RAL 9005**
nero opaco (20 gloss)
matt black (20 gloss)
noir mat (20 gloss)



● **VO1**
verniciato oro
gold painted
peinture or



● **VO2**
verniciato argento
silver painted
peinture argent



● **RAL 20/100**
opaco 20 gloss - lucido 100 gloss
matte 20 gloss - polished 100 gloss
mat 20 gloss - brillant 100 gloss

MDF non verniciato • No finish MDF • MDF non peinte



● **MO1**
MDF non verniciato
no finish MDF
MDF non peinte

Verniciatura a liquido (Dune) • Liquid paint finish (Dune) • Laquage par peinture liquide (Dune)

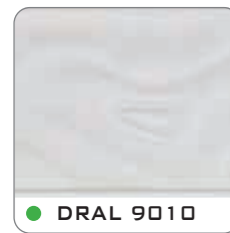

● **DRAL 9010**
bianco opaco (20 gloss)
matt white (20 gloss)
blanc mat (20 gloss)

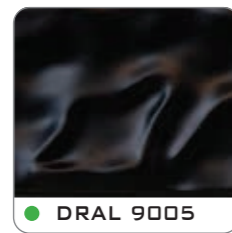

● **DRAL 9005**
nero opaco (20 gloss)
matt black (20 gloss)
noir mat (20 gloss)



● **DVO1**
verniciato oro
gold painted
peinture or



● **DVO2**
verniciato argento
silver painted
peinture argent

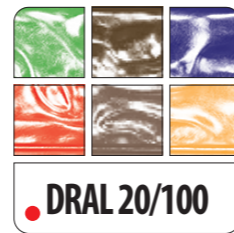

● **DRAL 20/100**
opaco 20 gloss - lucido 100 gloss
matte 20 gloss - polished 100 gloss
mat 20 gloss - brillant 100 gloss

Dune non verniciato • Dune no finish • Dune non peinte

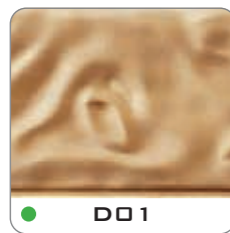

● **DO1**
Dune non verniciato
Dune no finish
Dune non peinte

Rivestimento in foglia (Dune) • Leaf finish (Dune)



● **DFO1**
oro patinato
gold coated
revêtement or

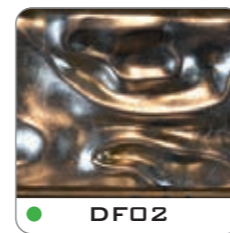

































● **DFO2**
argento patinato
silver coated
revêtement argent



 RAL 1001 BEIGE	 RAL 1002 SAND YELLOW	 RAL 1003 SIGNAL YELLOW	 RAL 1006 MAIZE YELLOW	 RAL 1007 DAFFODIL YELLOW	 RAL 5020 OCEAN BLUE	 RAL 6005 MOSS GREEN	 RAL 6011 RESEDA GREEN	 RAL 6019 PASTEL GREEN	 RAL 7000 SQUIRREL GREY
 RAL 1011 BROWN BEIGE	 RAL 1014 IVORY	 RAL 1015 LIGHT IVORY	 RAL 1019 GREY BEIGE	 RAL 1024 OCHRE YELLOW	 RAL 7001 SILVER GREY	 RAL 7003 MOSS GREY	 RAL 7004 SIGNAL GREY	 RAL 7006 BEIGE GREY	 RAL 7011 IRON GREY
 RAL 1034 PASTEL YELLOW	 RAL 2000 YELLOW ORANGE	 RAL 2003 PASTEL ORANGE	 RAL 2010 SIGNAL ORANGE	 RAL 3004 PURPLE RED	 RAL 7030 STONE GREY	 RAL 7032 PEBBLE GREY	 RAL 7035 LIGHT GREY	 RAL 7036 PLATINUM GREY	 RAL 7042 TRAFFIC GREY A
 RAL 3005 WINE RED	 RAL 3007 BLACH RED	 RAL 3009 OXIDE RED	 RAL 3012 BEIGE RED	 RAL 3017 ROSE	 RAL 8002 SIGNAL BROWN	 RAL 8007 FAWN BROWN	 RAL 8014 SEPIA BROWN	 RAL 8017 CHOCOLATE BROWN	 RAL 8019 GREY BROWN
 RAL 3031 ORIENT RED	 RAL 4001 RED LILAC	 RAL 4004 CLARET VIOLET	 RAL 4009 PASTEL VIOLET	 RAL 5003 SAPPHIRE BLUE	 RAL 8022 BLACK BROWN	 RAL 8025 PALE BROWN	 RAL 8028 TERRA BROWN	 RAL 9001 CREAM	 RAL 9002 GREY WHITE
 RAL 5004 BLACK BLUE	 RAL 5005 SIGNAL BLUE	 RAL 5008 GREY BLUE	 RAL 5012 LIGHT BLUE	 RAL 5014 PIGEON BLUE	 RAL 9003 SIGNAL WHITE	 RAL 9004 SIGNAL BLACK	 RAL 9005 JET BLACK	 RAL 9010 PURE WHITE	 RAL 9016 TRAFFIC WHITE

I colori stampati in questa cartella sono indicativi
The colours printed and shown in this folder are merely indicative
Les coloris imprimés ici sont indicatifs

CODE	Codice	Code	Code
	Temperatura (UR 50%)	Temperature (UR 50%)	Température (UR 50%)
	Tensione	Voltage	Tension
	Assorbimento	Absorption	Absorption
	Consumo KWh annui	kWh consumption per year	Consommation kWh annuelle
	Classe energetica	Energy efficiency rating	Classe énergie
Class	Classe climatica	Climate class	Classe climatique
	Pressione acustica Leq (h 155 cm - d. 100 cm)	Leq sound pressure level (h 155 cm - d 100 cm)	Leq niveau pression acoustique (h 155 cm - d 100 cm)
	Capacità	Capacity	Capacité
	Gas refrigerante	Refrigerant gas	Gaz réfrigérant
	Luce	Light	Lumière
	Led bianco caldo (3000 K - 30 led/mt - 1,12 W / mt - 130 lumen / mt)	brightwhite warm LED (3000 K - 30 led/mt - 1,12 W / mt - 130 lumen / mt)	LED blanc chaud (3000 K - 30 led/mt - 1,12 W / mt - 130 lumen / mt)
	Led bianco naturale (4000 K - 30 led/mt - 7,2 W / mt - 572 lumen / mt)	White natural daylight LED (4000 K - 30 led/mt - 7,2 W / mt - 572 lumen / mt)	LED blanc day-light naturel (4000 K - 30 led/mt - 7,2 W / mt - 572 lumen / mt)
	Led blu	Blue LED	LED bleue
	Controller RGB (30 led/mt - 7,2 W / mt - 550 lumen / mt)	RGB controller (30 led/mt - 7,2 W / mt - 550 lumen / mt)	Regulateur RGB (30 led/mt - 7,2 W / mt - 550 lumen / mt)
	Controller bianco dinamico (2700/6000 K - 140 led/mt - 19,2 W / mt - 2000 lumen / mt)	Dinamic white controller (2700/6000 K - 140 led/mt - 19,2 W / mt - 2000 lumen / mt)	Regulateur blanc dynamique (2700/6000 K - 140 led/mt - 19,2 W / mt - 2000 lumen / mt)
	Lato posteriore vetrina	Showcase back side	Face postérieure vitrine
	Ante in vetro	Glass doors	Porte en verre
	Pannello cieco	Blank panel	Panneau borgne
	Numero piani (base compresa)	Number of shelves (including base)	Nombre de tablettes (base comprise)
	Bottiglie	Bottles	Bouteilles
	Numero bottiglie da 0,75 Lt	Number of bottles 0,75 lt.	Quantité bouteilles 0,75 lt.
	Altezza e diametro massimo bottiglie	Maximum height and diameter of the bottles	Hauteur et diamètre maximum des bouteilles
	Presente	Present	Présent
-	Assente / dato non disponibile	Absent / data not available	Absent / information non disponible
	Dimensioni nette	Net dimensions	Dimensions nettes
	Dimensioni con imballo	Dimensions including packaging	Dimensions avec emballage
	Dimensioni con imballo su pedana	Dimensions including packing on pallet	Dimensions avec emballage sur palette
	Peso netto	Net weight	Poids net
	Peso con imballo	Weight with packaging	Poids avec emballage
	Peso con imballo su pedana	Weight with packing on pallet	Poids avec emballage sur palette
	Volume con imballo	Volume with packaging	Volume avec emballage
	Volume con imballo su pedana	Volume with packaging on pallet	Volume avec emballage sur palette
	Imballo in legno	Wooden packaging	Emballage en bois
	Numero colli	Number of packagings	Quantité colis